

The Advanced Carrier Based Pulse Width Modulation Using Third Injection Harmonic Reference Signal on Neutral Point Clamped Inverter

by I Ketut Wiryajati

Submission date: 21-Oct-2022 07:52AM (UTC+0700)

Submission ID: 1931057493

File name: Paper_MIMSE_22_Artikel_Advances_CBPWM_2022_REv_2022.pdf (713.15K)

Word count: 2220

Character count: 12031

The Advanced Carrier Based Pulse Width Modulation Using Third Injection Harmonic Reference Signal on Neutral Point Clamped Inverter

8

I Ketut Wiryajati,
Department of Electrical Engineering
University of Mataram
k.jatiwiryaya@unram.ac.id

I N 12 hyu Satiawan
Department of Electrical Engineering
University of Mataram

6 I B Fery Citarsa,
I M Budi Suksmadana
Department of Electrical Engineering
University of Mataram

6 I M Budi Suksmadana
Department of Electrical Engineering
University of Mataram

Supriono
Department of Electrical Engineering
University of Mataram

Abstract—This paper proposes development of a Pulse Width Modulation (PWM) scheme that overcomes the weakness of conventional Carrier-Based PWM (CBPWM) performance on Neural Point Clamp Inverter (NPC). This scheme uses the conventional CBPWM technique to developed Advanced CBPWM. This technique uses triangular carriers in different amplitudes that are arranged in composition, then injects the modulated signal that has been decomposed with the third harmonic. The proposed PWM schema was verified using MATLAB/Simulink software. By applying this scheme, the quality of power, voltage and current are improved, and finally Total Harmonic Distortion (THD) can be reduced.

Keywords— *Neural Point Clamp Inverter, CBPWM, NPC, inverter, THD, Advance CBPWM.*

I. INTRODUCTION

Multilevel inverter is one of the electronic devices that is very well known in the electric power systems application and in industry. Since multilevel inverter has high performance and produces low harmonics [1-3]. There are several types of multilevel inverters such as Neutral Point Clamped, (NPC) Flying Capacitor Inverters. In particular, the Neutral Point Clamped (NPC) converter is generally used at high voltages industry [4-7].

In conventional inverters, increasing the voltage level will increase the number of diodes, as well as for inverters using capacitors. In addition, the increase of voltage level causes higher cost and increasing of voltage unbalanced problem due to the use more diode or capacitor. Furthermore, the switching losses on the switches will also increase. However, Multilevel NPC inverters have advantages and disadvantages over the other inverters, because it no longer requires balancing on the diode or capacitor, this method only requires a separate dc voltage on each H-Bridge Inverter [8-10].

In this paper, an NPC inverter is used discussed. NPC will apply the proposed new modulation technique. The first development of a multilevel inverter was the NPC Inverter (INPC), this is because the topology has the following advantages:

1. The performance and waveform of the inverter is better especially at the fundamental frequency.

2. The use of capacitors can be charged first before being operated
3. The voltage level is very dependent on the capacitor voltage, namely in terms of voltage balance.

1 There are several modulation techniques to control the inverters. Such as Selected Harmonic Elimination (SHE) or Optimized Harmonic Stepped Waveform (OHSW), Space Vector PWM (SVPWM), and Carrier Based PWM (CBPWM)[11-13]. Among these modulation techniques, the easiest to apply to multilevel inverters is the CBPWM modulation technique. Although CBPWM technique is very easy to implement, there are several challenges or shortcomings of this technique, namely the quality of the power produced still decreasing. Several recent studies have explored to improve the quality of this power. conventional PWM, but uses a triangular signal composed of the reference signal that has been assigned a Third Harmonic Injection (THI) which is called a decomposition signal.

To answer this challenge, this paper proposes a new scheme called Advance Carrier Based Pulse Modulation (ACBPWM) with decomposed modulation signal. This scheme does not use a triangular carrier waveform in the same amplitude as in conventional PWM, but uses a triangular signal composed of the reference signal that has been assigned a Third Harmonic Injection (THI) which is called a decomposition signal

II. SINUSOIDAL DECOMPOSITION

A. SPWM (Sinus Pulse Width Modulation)

To generate a sinusoidal PWM signal, a sine wave is provided as the reference signal. The frequency of the sine wave is equal to the frequency of the desired output voltage with respect to the modulation of the carrier signal. The frequency of the carrier signal must be higher than the frequency of the reference signal. When both signals are modulated, it will generate a signal pulse for the switching device for the inverter as shown in Figure (1)

III. ADVANCE CARRIER BASED PULSE WIDTH MODULATION

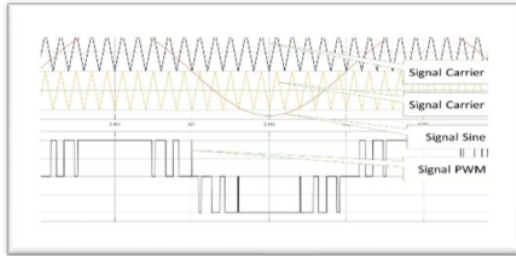

Figure 1 Sinusoidal Pulse Width Modulation (SPWM)

To generate these signals, equation (1) is used, likewise for harmonic signals. This signal will be used as a reference signal or modulation signal in the CBPWM.

$$V_m m \{ \sin(\omega_o t) + k. \sin(3. \omega_o t) \} \dots\dots\dots(1)$$

With V_m =Amplitude, ω_o =frequency, t =time, m =Modulation index, k = Orde harmonic.

B. Third Harmonic Injection Method

By injecting the third harmonic signal into a sinusoidal signal, we will get a decomposed modulation signal as shown in Figure 2

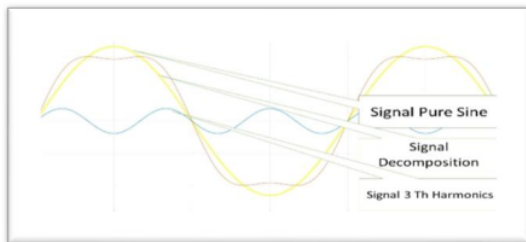

Figure 2 Decomposition with Third Harmonic.

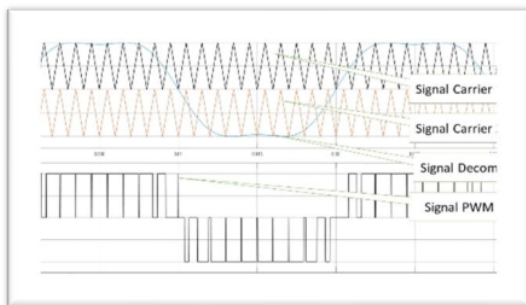

Figure 3 Decomposition signal with two signals
The reference or modulation signal is a third harmonic injection signal which will be modulated with a carrier signal as shown in Figure 3. After being modulated, this signal will generate a signal in the form of a pulse which can then be used as a switching device in the inverter. Signal switching as shown in Figure 3.

The carrier signal with a triangular shape will serve to get the trigger signal. The proposed method applies a simple logic: If the carrier wave is greater than or equal to the modulating wave the value is high and the switch is turned on and vice versa. Mathematically it can be written as follows:

$$\begin{aligned} \text{if } C_r \geq C_m \text{ then On} \dots\dots\dots (2) \\ C_r \leq C_m \text{ then Off} \end{aligned}$$

The general idea for CBPWM is to use multiple triangular carrier signals, with one carrier signal for each level. For the modulating signal (reference). A carrier signal can be used to signal each phase. If the CBPWM is applied for N phases, reference signal (modulation) corresponds to the number of phases. Figure 4 shows the modified reference signal and carrier signal with a phase shifted while the level is kept constant. The levels of the positive and negative sides are the same so that this CBPWM produces an inverter level 7 CBPWM.

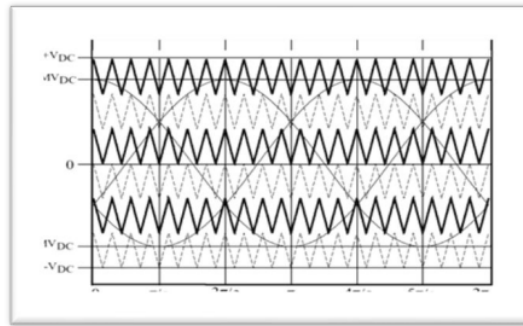

Figure 4. CBPWM 7 level

IV. PROPOSED SCHEME

A. Decomposition of Signals

The scheme proposed in this paper is shown in Figure 5. Each carrier wave in CBPWM has voltage amplitude a peak-to-peak (vpp) equal to that of each source DC voltage. In this figure, the peak-to-peak voltage (vpp) of the carrier wave 3 is -0.75 Vdc and the carrier signal 1 is 0.75 vpp while the carrier signal 2 is 0.25 Vdc and the negative of the carrier signal 4 is -25 Vdc, the vpp of the decomposition modulation signal is equal to VDC. Figure 5 shows the implementation of the proposed scheme is similar to the conventional CBPWM modulation technique, the difference is that the carrier signal shifted two up the positive axis and two down the negative axis. The signal amplitudes have the same magnitude, i.e. each other has the opposite value.

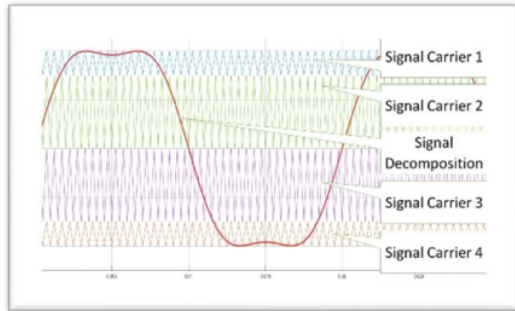

Figure 5 Composition of new carrier wave

TABLE I. PARAMETER DIODE AND IGBT

DIODE	IGBT
$C1=C2=4.7e-3$ F	$R_{on}=0.001$ Ω
$R1=R2=0.01$ Ω	$R_s=1e5$ Ω
R Snubber = $250e-9$ F	$C_s = \text{inf}$
$R_{on}=0.001$ Ω	Speed Time= $5e6$ s
R Snubber = 500 Ω	$V_{dc}=100$ Volt -
$V_f=0.8$ Volt	

B. Block Diagram of Advanced Carrier Based Pulse Width Modulation

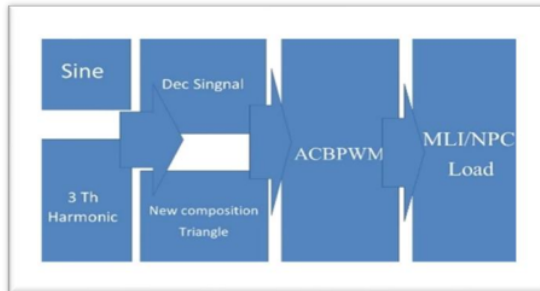

Figure 6. Block Diagram of ACBPWM

The first carrier wave with a value of 0.75 V_{dc} , the second carrier wave of 0.25 V_{dc} which is lowered to the level above, as well as for the negative side. The basic concept proposed this time is to use a Neutral Point Clamped multilevel inverter load. It looks like Figure 6. The parameters of the NPC inverter are shown in Table 1.

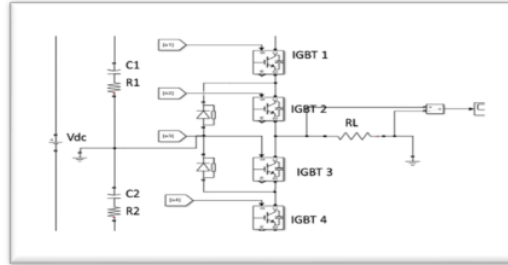

Figure 7. The Scheme of NPC With Resistive Load

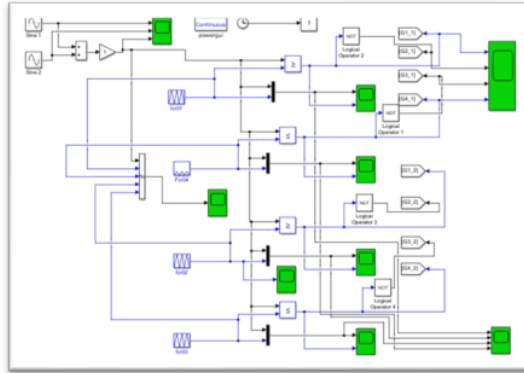

Figure 8 Scheme Detail for ACBPWM.

The block diagram of the ACBPWM control scheme is shown in Figure 10. The sine signal is injected with the third harmonic signal to produce a decomposition signal. The decomposition signal is compared with the new triangular pattern signal (New Composition) into ACBPWM which is then used to control the Multilevel Inverter, in this case the NPC. Figure 7 shows a single-phase NPC scheme using IGBT. The ACBPWM technique is shown in Figure 8 which is equipped with a measuring instrument using MATLAB Simulink software.

V. RESULT AND DISCUSSION

The results of the simulation of the proposed scheme are shown in Figures 8 to 12. Figure 9. shows the conventional CBPWM modulation technique. In this method the carrier signal has the same amplitude in the positive and negative cycles. The complete increase in the complete modulation index is shown in Table 2. Figures 9 to 11 show a decrease in THD. This decrease gives an indication that this technique can improve the power quality of the inverter. The details can be shown in Table 2.

By setting the modulation index from 0.1 to 1.15 , the decrease in THD is very noticeable as well as the increase in power quality

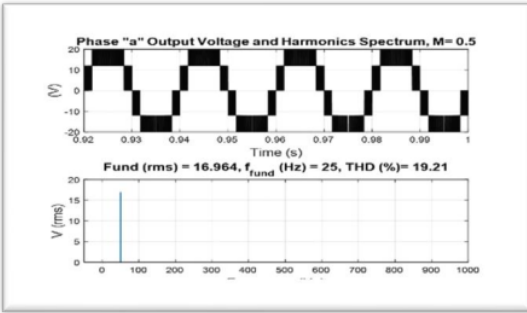

Figure 9. Voltage Output from Decomposition CBPWM.

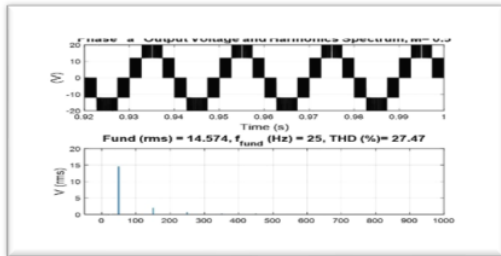

Figure 10. Signal Output from Advance CBPWM.

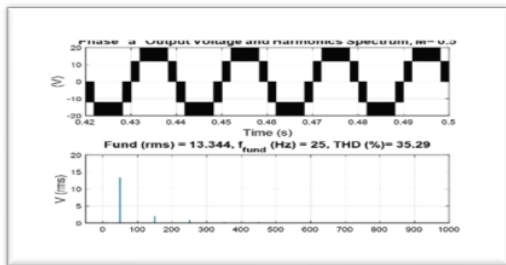

Figure 11. Signal Output from CBPWM.

VI. CONCLUSION

The control scheme of the Advanced CBPWM technique Multilevel Inverter which is applied by adjusting the position of the carrier signal in the form of a triangle signal and modifying the signal on the modulating signal with the third harmonic signal decomposition technique. The proposed scheme improves power quality, by using a fixed dc source. Changes in the mean THD of 19.21%, 27.5% and 35.28%. For Advance CBPWM, decomposition CBPWM, Conventional CBPWM respectively.

ACKNOWLEDGMENT

Acknowledgments to the University of Mataram, for its financial support, and the Power Electronics and Drives Research Group, for their cooperation.

REFERENCES

- [1] P. Ponnusamy, P. Sivaraman, D. J. Almkhles, S. Padmanaban, Z. Leonowicz, M. Alagu, and J. S. M. Ali, "A New Multilevel Inverter Topology With Reduced Power Components for Domestic Solar PV Applications," *IEEE Access*, vol. 8, pp. 187483-187497, 2020.
- [2] I. K. Wiryajati, I. Giriantari, I. Kumara, and L. Jasa, "Speed Control Strategy for Three Phase Induction Machine Fed Inverter Base on Carrier Base Pulse Width Modulation (CBPWM)."
- [3] A. A. Stonier, S. Murugesan, R. Samikannu, S. K. Venkatachary, S. S. Kumar, and P. Arumugam, "Power Quality Improvement in Solar Fed Cascaded Multilevel Inverter With Output Voltage Regulation Techniques," *IEEE Access*, vol. 8, pp. 178360-178371, 2020.
- [4] A. Taghvaie, M. E. Haque, S. Saha, and M. A. Mahmud, "A New Step-Up Switched-Capacitor Voltage Balancing Converter for NPC Multilevel Inverter-Based Solar PV System," *IEEE Access*, vol. 8, pp. 83940-83952, 2020.
- [5] M. S. Dasari and V. Mani, "Simulation and analysis of three-phase parallel inverter using multicarrier PWM control schemes," *SN Applied Sciences*, vol. 2, p. 958, 2020/04/24 2020.
- [6] V. Jayakumar, B. Chokkalingam, and J. L. Munda, "A Comprehensive Review on Space Vector Modulation Techniques for Neutral Point Clamped Multi-Level Inverters," *IEEE Access*, vol. 9, pp. 112104-112144, 2021.
- [7] Y. Dhote and B. Khambra, "Neutral Point Clamped Multi Level Inverter Based Unified Power Quality Conditioner," *Journal for Research Volume*, vol. 6, 2020.
- [8] M. Shamouei-Milan, M. Hassanifar, Y. Neyshabouri, S. Golshannavaz, and D. Nazarpour, "A New Hybrid T-type Nested Neutral Point Clamped (NNPC) Multilevel Inverter with Improved Voltage Balancing Strategy," in *2020 28th Iranian Conference on Electrical Engineering (ICEE)*, 2020, pp. 1-6.
- [9] E. Lee, S. Kim, and K. Lee, "Modified Phase-Shifted PWM Scheme for Reliability Improvement in Cascaded H-Bridge Multilevel Inverters," *IEEE Access*, vol. 8, pp. 78130-78139, 2020.
- [10] X. Guo, X. Wang, C. Wang, Z. Lu, C. Hua, and F. Blaabjerg, "Improved Modulation Strategy for Single-Phase Cascaded H-bridge Multilevel Inverter," *IEEE Transactions on Power Electronics*, pp. 1-1, 2021.
- [11] M. Sadoughi, A. Zakerian, A. Pourdadaashnia, and M. Farhadi-Kangarlu, "Selective Harmonic Elimination PWM for Cascaded H-bridge Multilevel Inverter with Wide Output Voltage Range Using PSO Algorithm," in *2021 IEEE Texas Power and Energy Conference (TPEC)*, 2021, pp. 1-6.
- [12] M. S. Sundari, "Simulation of Cascaded H-Bridge Multilevel Inverter using OHSW PWM for the elimination of harmonics."

- [13] H. Radmanesh and A. Kavooosi, "Novel Multilevel Inverter Switching Technique Based On Harmony Search Algorithm," in *2020 11th Power Electronics, Drive Systems, and Technologies Conference (PEDSTC)*, 2020, pp. 1-6.

Author Profile

I Ketut Wiryajati, Received the B.SC from Universitas Udayana, Denpasar, Master from Institute Teknologi Sepuluh Nopember Surabaya, And Doctor form Udayana University. He has been with Universitas Mataram since 1997 as senior Lecturer of Departement of Electrical Engineering. He is Research interests included Power Electronics and Drives, Control Intelgent System, and Renewable Energy.

I Nyoman Wahyu Satiawan, Received the B.SC from Universitas U Received the B.Sc from Udayana University, Denpasar. M.Sc. and Ph.D. from John Moores University, England. He has been with University of Mataram since 1998 as senior Lecturer at Department of Electrical Engineering University of Mataram. His Research interest includes Power Electronics and Drives and Intelligent Control System.

Ida Bagus Fery Citarsa, Received Bachelor's Degree in Electrical Engineering from Institut Teknologi Nasional

Malang, Master's Degree in Electrical Engineering from Universitas Gadjah Mada. He is a Lecturer in the Electrical Engineering Department of Universitas Mataram. His research interests include Power Electronics, Electrical Motor Drives, and Renewable Energy.

I Made Budi Sukmadana, Received the B.SC from Udayana University, Master from Gadjah Mada University. He is senior Lecturer of Departement Electrical Engineering Universitas Mataram. He is Research interests included Power Electronics, Drives, Control Intelgent System and Machine Learning

Supriono , Received the B.Sc. and Master degree from USU Medan and UGM Jogja respectively. He is senior Lecturer in Electrical Department, Engineering Faculty, Universitas Mataram. The Research interest is Power Electronics.

The Advanced Carrier Based Pulse Width Modulation Using Third Injection Harmonic Reference Signal on Neutral Point Clamped Inverter

ORIGINALITY REPORT

10%

SIMILARITY INDEX

7%

INTERNET SOURCES

8%

PUBLICATIONS

1%

STUDENT PAPERS

PRIMARY SOURCES

1	ijesrt.com Internet Source	2%
2	S. Albert Alexander, T. Manigandan. "Digital control strategy for solar photovoltaic fed inverter to improve power quality", Journal of Renewable and Sustainable Energy, 2014 Publication	1%
3	Submitted to Curtin University of Technology Student Paper	1%
4	Shui Lin Tu, Zhen Yi Wu, Zheng Yang Wu. "The Method of Feature Extraction of Weak Multi-Frequency Signals Based on the Array of Modulated Stochastic Resonance", Advanced Materials Research, 2012 Publication	1%
5	Zakaria Massaq, Abdelouahed Abounada, Mohamed Ramzi. "A New Space Vector Modulation Technique for a Hybrid 2/3-Level Inverter with Minimized Switching Losses",	1%

Arabian Journal for Science and Engineering, 2022

Publication

6	www.iiste.org Internet Source	1 %
7	Junsong Jia, Weimin Wang, Yongle Wu, Yuan'an Liu, Yuqin Yang, Hui Li, Hua Xu. "TERAHERTZ CHANNEL MEASUREMENTS FOR DIFFERENT ANGLES AND DIFFERENT OBSTACLES", Progress In Electromagnetics Research M, 2022 Publication	1 %
8	ojs.unud.ac.id Internet Source	1 %
9	J S Sakthi Suriya Raj, Ajith Kumar Prabhakaran. "Pulse Width Modulation Technique for Nine-phase Electric Vehicle Drive System", IOP Conference Series: Materials Science and Engineering, 2021 Publication	1 %
10	Xinyu Niu, Jingdong Wu, Linen Zhang. "A Research on Modulation in Digital Communication System", Journal of Physics: Conference Series, 2021 Publication	1 %
11	mail.ijrer.org Internet Source	1 %

12

pen.ius.edu.ba

Internet Source

1 %

13

www.degruyter.com

Internet Source

1 %

14

www.ncbi.nlm.nih.gov

Internet Source

1 %

Exclude quotes On

Exclude matches < 1%

Exclude bibliography On

The Advanced Carrier Based Pulse Width Modulation Using Third Injection Harmonic Reference Signal on Neutral Point Clamped Inverter

GRADEMARK REPORT

FINAL GRADE

/0

GENERAL COMMENTS

Instructor

PAGE 1

PAGE 2

PAGE 3

PAGE 4

PAGE 5
