

# Effect of Blade number and Directional Plate Angle on Kinetic Turbine Performances

*by* Sukmawaty Sukmawaty

---

**Submission date:** 08-Apr-2023 10:00AM (UTC-0500)

**Submission ID:** 2059029160

**File name:** and\_Directional\_Plate\_Angle\_on\_Kinetic\_Turbine\_Performances.pdf (302.06K)

**Word count:** 2763

**Character count:** 14204



# <sup>1</sup> EFFECT OF BLADE NUMBER AND DIRECTIONAL PLATE ANGLE ON KINETIC TURBINE PERFORMANCES

S. Sukmawaty, N. Firdaus, G.M.D. Putra and S.D. Ajeng

Agricultural Engineering Faculty of Food and Agroindustrial Technology, University of  
Mataram, Jl. Majapahit no. 62, Mataram, NTB, 83125, Indonesia

M. Mirmanto

Mechanical Engineering Department, Engineering Faculty, Mataram University,  
Jl. Majapahit no. 62, Mataram, NTB, 83125, Indonesia

## ABSTRACT

Water turbine is the key component of a micro hydropower plant on utilizing potential and kinetic energy of water stream. This research is aimed to optimizing the kinetic blade performance by varying the blade numbers and directional plate angle. This research was conducted on a laboratory scale experiment using a vertical axis kinetic turbine with various blade numbers and directional plate angles. The blade numbers varied were 6, 10, and 12, while the directional plate angle variations were 10°, 20°, and 30°. The results show that the kinetic turbine with blade number of 12 and the directional plate angle of 30° has superiority over all parameters. The obtained inlet and outlet flow discharges were 0.00648 m<sup>3</sup>/s and 0.00269 m<sup>3</sup>/s. The turbine rotational speed gained was 164.33 rpm, and the turbine produced water power and electric power of 0.02944 W and 0.0093 W respectively. The efficiency of 54.608% was the highest achievement in this study.

**Keyword head:** Kinetic turbine, blade number, directional plate angle, efficiency.

**Cite this Article:** S. Sukmawaty, N. Firdaus, G.M.D. Putra, S.D. Ajeng and M. Mirmanto, Effect of Blade Number and Directional Plate Angle on Kinetic Turbine Performances, International Journal of Mechanical Engineering and Technology, 9(13), 2018, pp. 395–402

<http://iaeme.com/Home/issue/IJMET?Volume=9&Issue=13>

## 1. INTRODUCTION

The demand on fossil energy has been increasing significantly from year to year. The excessive exploration has been promoting fossil fuel reduction. Formation of fossil fuel requires extensive process, furthermore it produces global effects. Though enabling environmental degradation, fossil fuels remain the main option for everyday use of the society. Experts argue, with the increasing consumption patterns, it is estimated that in the next 50 years, we will be facing the end of the world. If this continues, a global crisis will appear. To reduce the use of fossil fuels, it is necessary to search alternative energy to replace fossil fuel.

Hydropower is an alternative energy that is environmentally friendly, which has been used since centuries. It is a form of clean renewable and sustainable energy making use of the available flow or head in water without consuming or polluting the water itself, Niebuhr et al. [1]. This energy utilizes the available potential and kinetic energy. Micro Hydropower Plant (MHP) is a small-scale power plant that uses hydropower as its driving force. Technically, MHP has three main components, i.e. water (as an energy source), turbines, and generators.

The water turbine is a key component of MHP. Kinetic turbine is one type of generator turbine that uses low-speed hydropower, such as in river flow. Turbine performance is affected by several factors, i.e. flow speed, blade angle, directional blade, blade dimensions, and the number of blades. Various studies on accelerating the water flow using turbines blade shapes and number have been conducted. According to Pieters et al. [2], a number of blades could increase the rotational and tangential forces, thus increasing the kinetic turbine's working power. The previous researcher, such as Yani [3], stated that curved blades have higher strength and efficiency, compared to flat and bowl blade. However, experiments regarding the characteristics and the effectiveness of the curved blades with variations of the blade number and directional plate angles still have been limited. Therefore, such a turbine with various blade number and directional plate angle is investigated in this study.

## 2. MATERIALS & EXPERIMENTAL PROCEDURES

Material and equipment that were used in this study include: water pump, tachometer, power analyzer, stopwatch, compasses, protractor, marker, crossbar, stop faucet, bike generator, light bulb, 2 inch pipe, pulley, glass, glue, shaft, iron plate, v-belt, reservoir, and kinetic turbine.

This research used the experimental method in a laboratory. The numbers of blades used were 6, 10, and 12 as shown in Figure 2, while the directional plate angles varied were 10°, 20°, and 30°. Water was pumped from the water reservoir through the pipe and flowed to the channel where the kinetic turbine was placed. The directional plate angle was placed in front of the turbine to adjust the water coming into the turbine blades. Due to the flow of water, then the turbine turned around and the torque of the turbine was transferred using v belt to the generator, and then the lamp was on due to the electricity coming out from the generator.

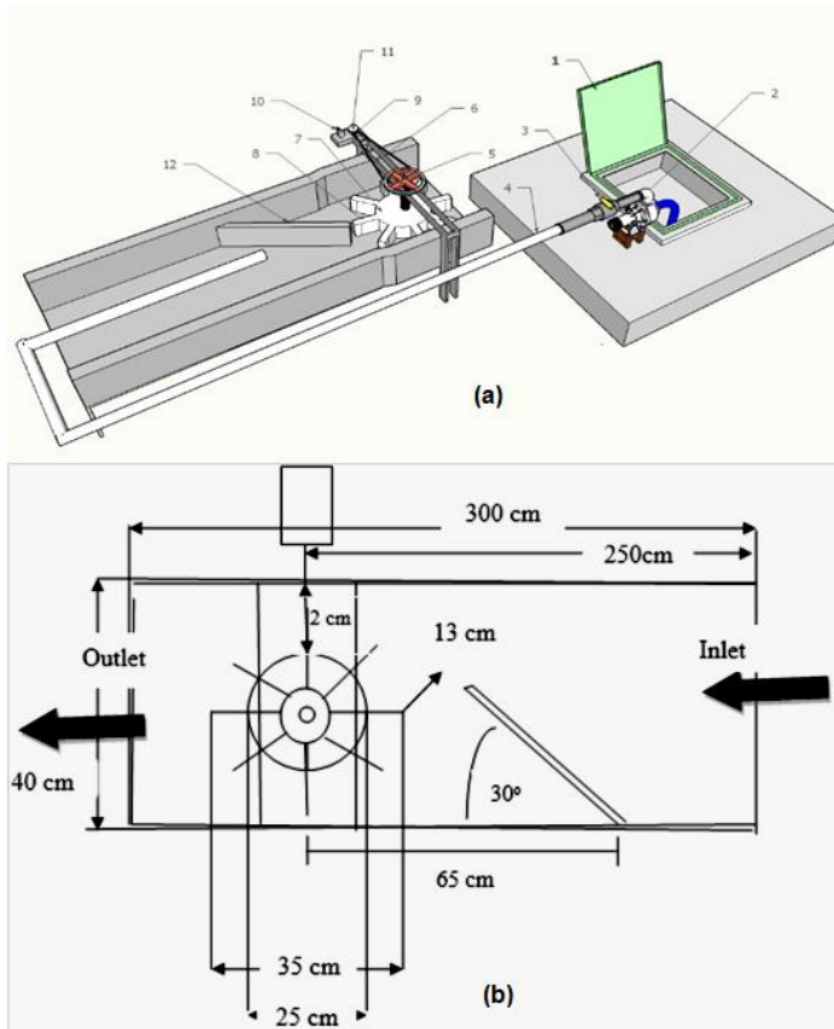

4  
**Figure 1.** Schematic diagram of the experimental apparatus; (a) layout of the apparatus, (b) the dimension of the apparatus. 1. Water reservoir, 2. Pump, 3. Valve, 4. Pipe, 5. Big pulley, 6. V-belt, 7. Runner, 8. turbine blade, 9. Generator, 10. Lamp, 11. Small pulley, 12. Directional plate.

The water discharge data were collected in the inlet and outlet and it can be predicted using equation (1), which can be obtained in Olson and Wright [4].

$$Q = vA \quad (1)$$

$Q$  is the water discharge ( $m^3/s$ ),  $A$  is the cross-sectional area ( $m^2$ ), and  $v$  is the water velocity ( $m/s$ ), which was measured using a current meter. However, in this study, the water discharge was measured using a volume meter and a stopwatch. Meanwhile, the rotation of the turbine was measured using a tachometer. The water power is estimated using equation (2) that is taken from Yani [3], Alit et al. [5].

$$Pa = \rho Av^3 / 2 \quad (2)$$

$P_a$  is the water power (W),  $\rho$  is the density (kg/m<sup>3</sup>). The output power of the generator can be obtained using equation (3). This equation also can be obtained in Alit et al. [5], Mirmanto et al. [6].

$$P = VI \tag{3}$$

$P$  represents the electrical power (W) generated by the generator,  $V$  is the output voltage (V) and  $I$  is the current (A). The voltage and the current were measured using a multimeter or power analyzer.

The channel section of the installation was made of glass which was supported by an iron plate of 300 cm length and 40 cm width. The turbine shaft was 1.5 cm in diameter. The dimension of the runner turbine was 9 cm in diameter, with the blade length and height of 14 cm and 10 cm respectively. Therefore, the overall length of the turbine was 35 cm. The directional plate was 50 cm long, with angles of 10°, 20°, and 30°. The distance between the directional plate and the turbine shaft was 65 cm.

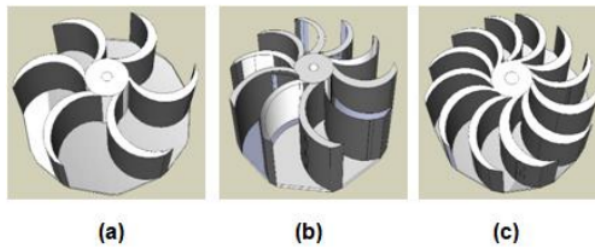

**Figure 2.** Blade number variation; (a) 6 blades, (b) 10 blades, (c) 12 blades

Efficiency is the ratio of the output electric power (generated by the turbine) to the water power. To calculate the efficiency, the equation (4) can be utilized. This equation can be attained in Maidangkay et al. [7], Alit et al. [5].

$$\eta = \frac{P}{P_a} 100\% \tag{4}$$

$\eta$  is the efficiency in (%).

### 3. RESULTS AND DISCUSSION

Water discharge is a measurement of water volume flow through the channel per unit of time. Discharge data were collected using 3 replications on each treatment (6, 10 and 12 blades). The average water discharge value was then calculated using the data as presented in Table 1.

Table 1 shows that the average value of inlet flow discharge in the kinetic turbine installation is approximately 0.00648 m<sup>3</sup>/s. However, the inlet discharge was higher in all variations of blade number. This difference might happen due to the occurrence of a back force collision at the directional plate.

**Table 1.** Water discharge calculation

Replication	Volume	Time	Discharge	Flow velocity
	(m <sup>3</sup> )	(s)	(m <sup>3</sup> /s)	(m/s)
1	0.08	13.7	0.00583	0.32084
2	0.08	11.5	0.00695	0.38222
3	0.08	12	0.00666	0.36630
Average	0.08	12.4	0.00648	0.35645

Figure 3 shows the relationship of the outlet discharge and the blade number. As shown in Figure 3, the higher the angle of the directional plate, the higher the outlet discharge. The maximum outlet discharge was 0.00269 m<sup>3</sup>/s, while the minimum was 0.00203 m<sup>3</sup>/s. Water flow discharge could be affected by several factors, i.e. flow velocity, channel cross-sectional area, required time for water to flow through the turbine, wind, rain, etc. According to the previous study, Niebuhr et al. [1], the higher the water discharge, the greater the kinetic turbine rotation. Further investigation using analysis of variance (ANOVA) method shows that the value of *f* calculation is 12.3793, which is higher than *f* table of about 3.0087. This means that the number of the blade of kinetic turbine has a significant effect on water discharge.

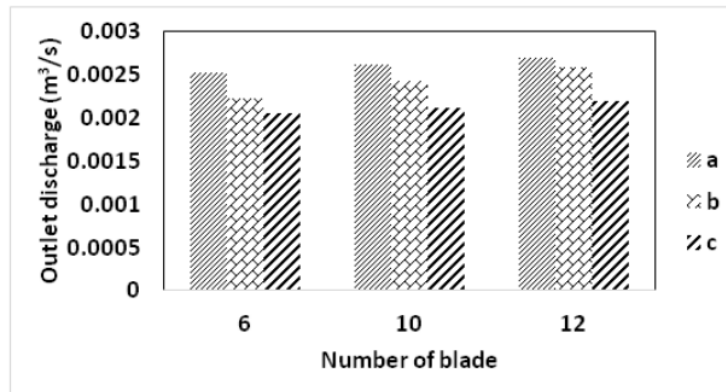

**Figure 3.** Effect of blade numbers and directional plate angles on flow discharges. The directional plate angles of (a) 30°, (b) 20°, and (c) 10°.

The kinetic turbine rotational speed is defined as the rotational speed of pulley above the turbine which is measured using a digital tachometer. The effect of blade number on turbine rotational speed had been investigated as shown in Figure 4. Based on Figure 4, the kinetic turbine with 12 blades has the highest rotational speed and then followed by turbines with 10 and 6 blades respectively at each directional plate angle. This might happen due to water velocity in 12 blades turbine was higher compared to the others. The more blades are used, the less cross-sectional area of the channel. Theoretically, the smaller the cross-sectional area of the channel, the faster the water flow, Olson and Wright [4]. Furthermore, the highest water discharge occurs in this condition, which leads to greater flow velocity; as a result, the turbine's rotational speed is greater. This phenomenon was also found by Nastain and Suroso [8]. Further investigation using analysis of variance (ANOVA) method shows that the value of *f* calculation is 30.0265, which is higher than *f* table of 3.0087, thus, the number of blades and the directional plate angle greatly affect the rotational speed of the kinetic turbine.

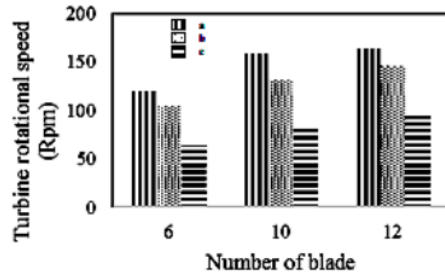

**Figure 4.** Effect of blade number and directional plate angle on rotational speeds, at the directional plate angles of (a) 30°, (b) 20°, (c) 10°.

Based on Figure 5, it can be seen that increasing the directional plate angle elevates the water power. The directional plate angle of 30° gives the highest water power value. It is of approximately 0.02944 W, while that of 20° produces 0.01510 W, and that of 10° results in 0.00541 W. The distant gap value of water power might imply as a decreasing water power phenomenon due to lack of turbines effectiveness on manipulating the received water power. The issue of random water flow movement tends to be the factor that causes blocking on the turbine rotation, especially for backward blades Kristanto [9]. The analysis using a variance (ANOVA) method indicates that the two parameters affect the water power significantly due to the *f* calculation of being higher compared to the *f* table.

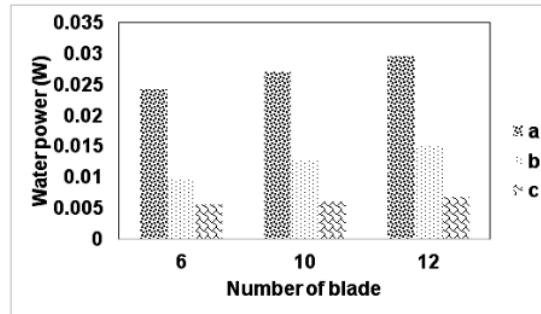

**Figure 5.** Effect of blade number and directional plate angle on water power, at the directional plate angles of (a) 30°, (b) 20°, (c) 10°.

Electricity power is defined as the amount of energy produced in a circuit, which is determined by multiplying the voltage and the current Akbar [10]. Data of the electric voltage and current were measured using power analyzer. Figure 6 shows data of produced electric power on various blade numbers in different directional plate angle.

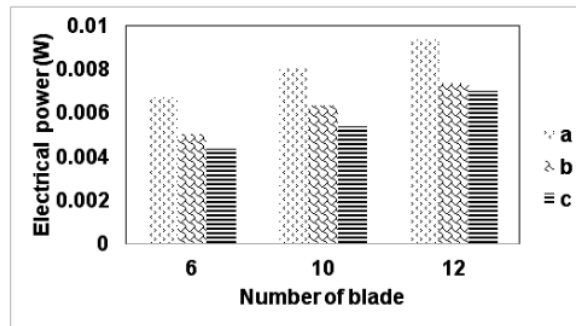

Figure 6. Effect of the blade number and the directional plate angle on the electrical power at the directional plate angles of (a) 30°, (b) 20°, (c) 10°.

Based on Figure 6, it can be seen that the directional angle of 30° gives higher turbine electrical power compared to those of 20° and 10°. Furthermore, increasing the blade numbers levels the electrical power. The highest electrical power is obtained using the kinetic turbine with 12 blades and a directional angle of 30°. It is of about 0.0093 W. Meanwhile, the lowest electrical power occurs at the turbine with 6 blades and the directional angle of 10°. It is of approximately 0.0043 W. According to Akbar [10], the electrical power produced by the turbine depended on the amount of voltage and electric current resulted. In addition, water discharge indirectly promotes the generation of electrical power. The higher the water discharge and the turbine rotation, the higher the electrical power attained, Pietersz et al. [2].

Successfulness of the kinetic turbine can be indicated by the efficiency, which is a comparison of the output power (electrical power) to the water power Maidangkay et al. [7], Alit et al. [5], Mirmanto et al. [6]. Figure 7 shows data of efficiency to a number of the blade.

Figure 7 shows that the directional plate angle of 30° results in higher efficiency compared to those of 20° and 10°. The turbine with 12 blades turbine also indicates the highest efficiency compared to that with 10 and 6 blades. The maximum turbine efficiency obtained is 54.608%.

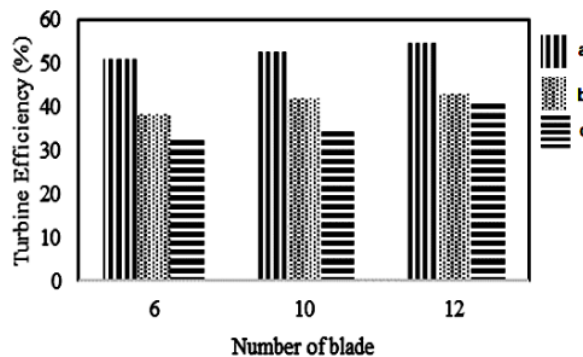

Figure 7. Effect of the blade number and the directional plate angle on the efficiency at the directional plate angles of (a) 30°, (b) 20°, (c) 10°.

#### 4. CONCLUSION

Increasing the blade number and the directional plate angle generally elevates the performance of the turbine. The kinetic turbine with 12 blades and the directional plate angle of 30° has superior performances. The obtained inlet and outlet flow discharges also increase with the



increase in the blade number and the directional plate angle. The turbine rotational speed, water power, electrical power, and efficiency are affected by the blade number and the directional plate angle in these particular experimental conditions.

## REFERENCES

- [1] Niebuhr, C., van Dijk, M., and Bhagwan, J. Technical and Practical Valuation of Hydrokinetic Turbine Integration Into Existing Canal Infrastructure In South Africa: A Case Study, Proceedings 2018, 2, 595.
- [2] Pietersz, R., Soenoko, R., and Wahyudi, S. Pengaruh Jumlah Sudu terhadap Optimalisasi Kinerja Turbin Kinetik Roda Tunggal. *Jurnal Rekayasa Mesin*, 4(3), 2013, pp. 220 – 226.
- [3] Yani, A. Pengaruh Variasi Bentuk Sudu terhadap Kinerja Turbin Air Kinetik (Sebagai Alternatif Pembangkit Listrik Daerah Pedesaan). *Jurnal Teknik Mesin*, 5 (1), 2016, pp. 8-13.
- [4] Olson, R.M., and Wright, S.J. Essential of Engineering Fluid Mechanic fifth Edition. Harper and Row Publisher, Inc., 1990.
- [5] Alit, I.B., Mirmanto, Adnyani, I.A.S., Mulyanto, A., and Susana I.G.B. Experimental Performance of A Modified Savonius Turbine for Small Scale Portable Wind Power Generation. *International Journal of Mechanical Engineering and Technology IJMET*, 9(6), 2018, pp. 1166-1173.
- [6] Mirmanto, M., Mulyanto, A., and Anugerah, B. Turbin Air Tesla dengan Variasi Diameter Lubang Keluaran. *Techno*, 19(2), 2018, pp. 71-78.
- [7] Maidangkay, A., Soenoko, R. and Wahyudi, S. Pengaruh Sudut Pengarah Aliran dan Jumlah Sudu Radius Berenssel Luar Roda Tunggal terhadap Kinerja Turbin Kinetik. *Jurnal Rekayasa Mesin*, 5(2), 2014, pp. 149-156.
- [8] Nastain and Suroso, *Mekanika Fluida*. Jurusan Teknik Sipil, Unsud, Purwokerto, 2005.
- [9] Kristanto, B. Analisa Pengaruh Jumlah Sudu Terhadap Kinerja Turbin Kinetik Tipe Poros Vertikal. Skripsi. Jurusan Teknik Mesin, Fakultas Teknik, Universitas Nusantara PGRI Kediri, 2016.
- [10] Akbar, B. Mempelajari Bentuk Sudu Runner pada Berbagai Debit dengan Ketinggian Air Masukan yang Sama pada Sistem Mikrohidro Skala Laboratorium. Skripsi, Universitas Mataram, 2016.

# Effect of Blade number and Directional Plate Angle on Kinetic Turbine Performances

## ORIGINALITY REPORT

17%

SIMILARITY INDEX

12%

INTERNET SOURCES

15%

PUBLICATIONS

%

STUDENT PAPERS

## PRIMARY SOURCES

1	<a href="http://www.neliti.com">www.neliti.com</a> Internet Source	3%
2	<a href="http://iaeme.com">iaeme.com</a> Internet Source	2%
3	A N E B Santoso, A Fahrudin, Iswanto. "Experimental Study of Blade Angle Effect on Two-Stage Vertical Shaft Hydrofoil Water Turbines on Power and Efficiency", IOP Conference Series: Materials Science and Engineering, 2020 Publication	2%
4	<a href="http://eprints.unram.ac.id">eprints.unram.ac.id</a> Internet Source	2%
5	<a href="http://repository.up.ac.za">repository.up.ac.za</a> Internet Source	2%
6	<a href="http://ajouronline.com">ajouronline.com</a> Internet Source	1%
7	Salahuddin, Bakhtiar, Yusman, Fadhli. "Efficiency of AX.25 Protocol in a Wireless	1%

SCADA Communication System for Monitoring Performance of Micro-Hydro Power Plants", IOP Conference Series: Materials Science and Engineering, 2019

Publication

---

8

G M D Putra, D A Setiawati, Murad. "Study of mathematics modeling on ginger geometric changes during drying using image analysis", IOP Conference Series: Earth and Environmental Science, 2021

Publication

---

1 %

9

Mirmanto, I Wayan Joniarta, Agung Tri Wijayanta, Pranowo, Muhammad Habiburrahman. "Experimental Performance of a Cooler Box with Heat Dissipation Unit Variations", International Journal of Heat and Technology, 2019

Publication

---

1 %

10

[link.springer.com](https://link.springer.com)

Internet Source

---

1 %

11

Nailul 'Atifah, Bambang Herlambang, Edi Tri Astuti, Tio Putra Wardana. "Analysis performance of mini pelton turbine", AIP Publishing, 2022

Publication

---

1 %

12

[hdl.handle.net](https://hdl.handle.net)

Internet Source

---

1 %

---

Exclude quotes      On

Exclude matches      < 1%

Exclude bibliography      On

# Effect of Blade number and Directional Plate Angle on Kinetic Turbine Performances

---

GRADEMARK REPORT

---

FINAL GRADE

**/0**

GENERAL COMMENTS

**Instructor**

---

PAGE 1

---

PAGE 2

---

PAGE 3

---

PAGE 4

---

PAGE 5

---

PAGE 6

---

PAGE 7

---

PAGE 8

---