

CFD Simulation of Velocity Effect on Flow Characteristic of Biofluid in Microchannel Permeable Membrane

Nur Kaliwantoro^{1)*}, IGNK Yudhayadi²⁾, Feri Fadli³⁾, I Kade Wiratama⁴⁾, Sujita Darmo⁵⁾

^{1), 2), 3), 4), 5)} Mechanical Engineering, Department of Mataram University, Jl. Majapahit No. 62 Mataram. Indonesia

Corresponding author: nurkaliwantoro@unram.ac.id

Abstract. Chronis kidney disease is one of the health problem in Indonesia. The common therapy is using hemodialyzer machine. The effectiveness of the dialyzer depend on the mass transfer through the membrane. This paper in aimed to simulate the fluid flow of biofluid through the microchannel permable membrane with dimension of 4 mm x 10 mm, with thickness of 10 micrometer, and pore size of 3 micrometer. The result show that the bigger the mass transfer occurs through the permeable membrane. The fluid flow of 10, 20, 30 and 40 ml/minute causes the diffusion rate of 6.5, 8.9, 18.34 and 28 ml/minute each. The shear stress in the corrsponding fluid flow are 42.75, 39.99, 34.57 and 31.21 Pa. While the transmembrane pressure resulted by the cporresponding fluid flow are 1050.74, 1125.28, 1704.68 and 2633.68 Pa, each.

Keywords: CFD Simulation, Biofluid, microchannel, permeable membrane.

1. Introduction

Recently, chronic kidney disease (CKD) has become one of the top health problem in many countries, including Indonesia. In 2018 the total CKD cases are reported up to 150000 patients [1]. The cost for each hemodilayzed therapy per persons at around Rp. 1.000,000.- , and must be done 8 times monthly as an ideal therapy.. The cost of CKD medication that must be paid by government is the second of the highest after heart therapy. One of the factor that has significant contribution on the high cost of CKD medication is the expensive price of the hemodialyzer, as well as the expensive of its maintenance and operational cost. Such condition causes many patients can not be covered by the hemodialysis therapy service.

The performance of hemodialyzer is highly determined by the mass transfer in the dialyzer. One of significant parameter of the mass transfer in the dialyzer are the velocity and the pressure of the blood and dialysate.[2; 3; 4]. Although study of the fluid velocity has been held by many researchers, but many aspects have not been explored yet.

2. Method

2.1. Governing Equations

The general mathematical statements of fluid flow are the conservation equations: mass, momentum and energy. Since biofluid in the microchannel segments is adiabatic, the energy equation can be ignored, leaving the continuity and momentum equations as the governing relations for flows of interest in the present study. The Navier–Stokes equations were solved over the domain using a finite volume method with the code developed in commercial CFD software. The equations were applied with constant viscosity and density, without body force, while the blood is assumed as incompressible and steady flow.

The diffusion parameter was determined using the equation:

$$D = \frac{Q_{Bi}(C_{Bi}-C_{Bo})}{(C_{Bi}-C_{Do})}$$

Where:

D = Diffusion (ml/minute)

C_{Bi} = Concentration of inlet biofluid

C_{Bo} = Concentration of outlet biofluid

C_{Do} = Concentration of outlet dialysate

2.2. CFD Model

The model developed based on the experiment using infusion biofluid that flowed in the parallel plate flow chamber. Permeable membrane with pore size of 3 micrometer with dimension of 4 mm x 10 mm was placed on the bottom edge of the parallel plate flow chamber. Infusion fluid was then flowed at the rate of 10; 20; 30 and 40 ml/second. While the dialysate was flowed at the double rate. In the simulation, the number of pore was limited to 100 hole. The hole was distributed uniformly in the area of 4 mm x 100 above. The biofluid used was infusion fluid that usually given to patient.

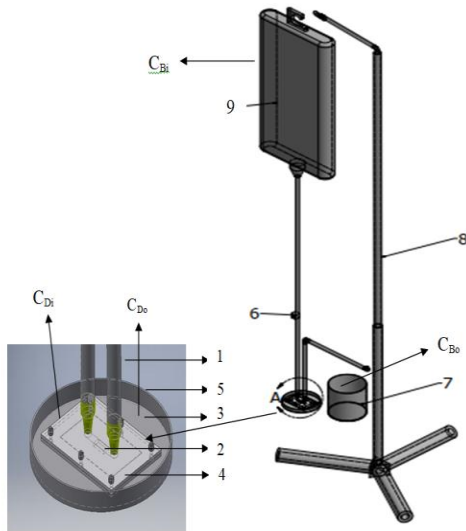
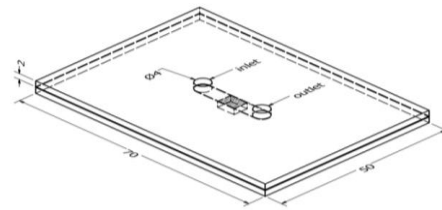

Figure 2. Experimental setup



Physical value for the model.

- Membrane thickness = 10 micrometer
- Pore diameter = 3 micrometer
- Membrane dimension = 4 mm x 10 mm
- Number of pores = 100
- infusion fluid ρ = 1050 kg/m³
- μ = 1,066 m²/s
- ν = 0,0010028 m²/s
- Dimension of PPFC = 50 mm x 70 mm

Figure 2. Model of parallel plate flow chamber

3. Result and Discussion

3.1. Velocity Profile and Wall Shear Stress on the surface of the permeable membrane

Mass transfer through the permeable membrane is highly affected by the velocity of the biofluid flowing through the microchannel. Figure 3 showed the velocity contour of the biofluid. While Figure 4 showed the biofluid route in the microchannel of the parallel plate flow chamber.

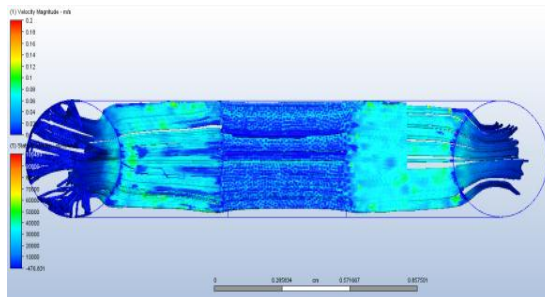

Figure 3. Velocity contour of biofluid

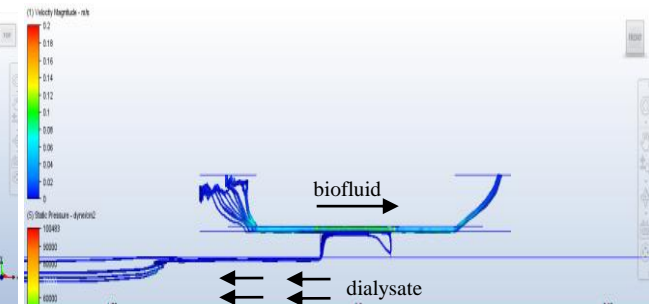

Figure 4. Route of biofluid in microchannel

The velocity in the inlet region is slower and become faster in the area before the membrane due to the smaller cross area between the upper and lower plate of the parallel plate flow channel. In the next route, the biofluid flow slower again in the permeable membrane region. The slower velocity in the membrane region occurs due to the leakage of some biofluid to the lower compartment as shown in Figure 4. The mean velocity and the shear stress at various fluid capacity is given by the Table 1 below.

Table 1. Characteristic of the biofluid flow

Biofluid Capacity (ml/minute)	Velocity inlet (m/s)	Velocity on the membrane surface (m/s)	Shear stress on the membrane (Pa)	Pressure on the membrane (Pa)
10	0.0132	0.018408	2.485891	1050.74
20	0.0265	0.018162	2.541693	1125.28
30	0.0398	0.018289	2.918289	1704.68
40	0.0530	0.021045	3.310569	3636.98

Capacity ratio between biofluid to dialysate = 1:2

Table 1, shows that the rise of velocity above the membrane is lower than the rise of velocity in the inlet. It is occurred due to the leakage of some biofluid to the lower compartement through the pore of the permeable membrane. When the capacity increased 4 fold, the rise of velocity on the surface of the membrane only rises 0.14 fold. It is indicated that the higher the capacity supplied to the microchannel membrane, the higher the fluid leakage occurred.

The velocity profile across the microchannel was shown in Figure 5. The profile shows lower velocity in the beginning of the microchannel, rises slightly to the center, and reduced slightly again until reaching the last region of the membrane. The velocity profile is the same for the four various fluid capacity.

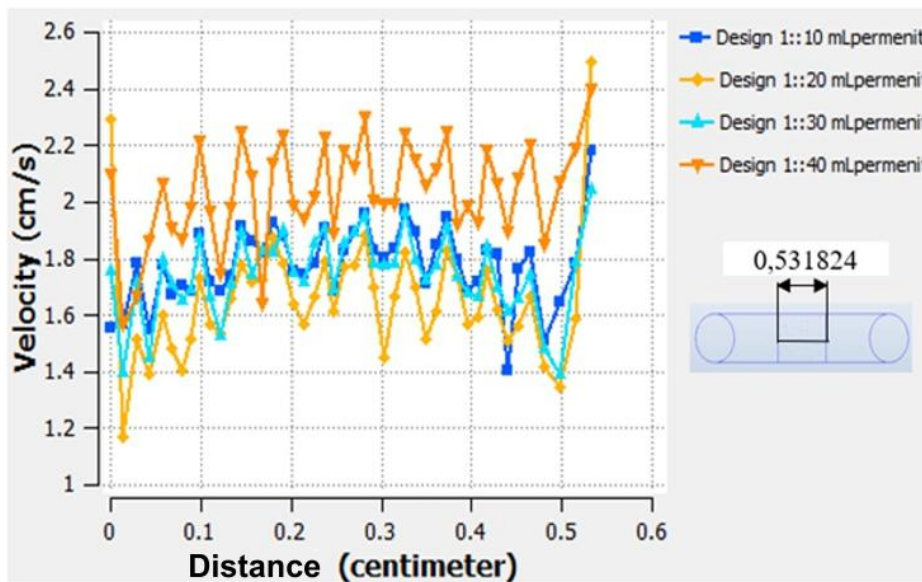

Figure 5. Velocity profile of the biofluid flow on the membrane surface

3.2. Velocity Profile in The Pore of The Membrane

The pore observed in this research has diameter of 3 micrometer. While the thickness of the membrane was 10 micrometer. When flowed in the permeable membrane, some of the biofluid leaks to the lower compartment through the pore with velocity of 0.06 m/s up to 0.085 m/s, as shown in Figure 6. Those velocities are about 4 times higher than the velocity of the biofluid flowed on the membrane surface.

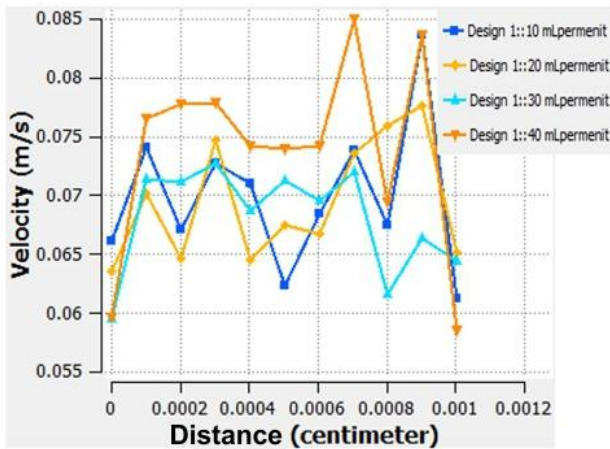

Figure 6. Velocity of the biofluid flow in the pore of the membrane

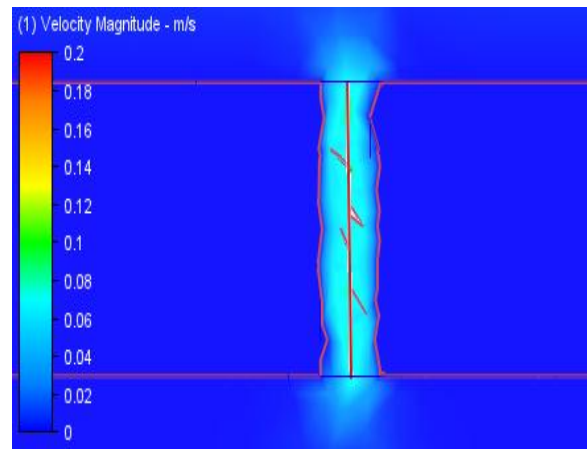

Figure 7. Velocity contour of the biofluid flow in the pore

The velocity contour as shown in Figure 6 and Figure 7 indicated that the highest velocity occurs at the center diameter of the pore. The above figure shows that the velocity is lower at the beginning of the pore, rise slightly up to 80% of the channel, and reduce again until, the end of the channel. This results matches well with the published dengue infection work [5].

3.3. Pressure of the Biofluid on the Surface of the Membrane

As shown in Figure 8, the pressure of the biofluid reduced deeply when flowing in the microchannel permeable membrane. Such profile is identic for the four fluid capacity observed in the recent work. This finding occurs due to the combination of relatively high viscosity of the biofluid, as well as the narrow cross section of the microchannel.

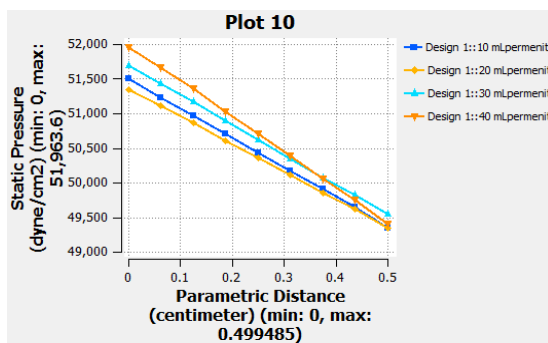

Figure 8. Pressure of the biofluid flowed on the surface the membrane

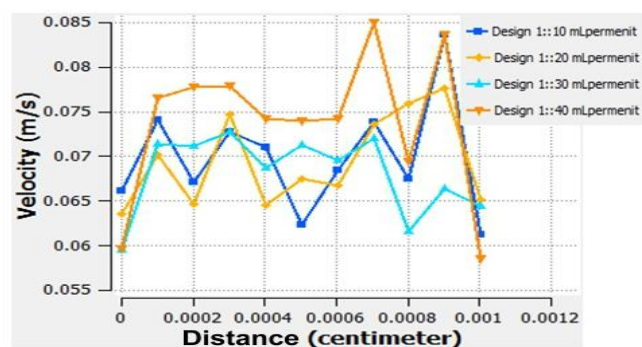

Figure 9. Pressure distribution in the pore

The observation of the pressure in the pore also resulted the same profile to the pressure distribution on the membrane surface. But the range of the pressure in the pore only 1000 Pa to 5000 Pa, compare to 49500 to 52000 Pa, observed on the membrane surface. It is means that the pressure in the pore only about 2,5% of the pressure in the membrane surface.

3.4. Diffusion of the Biofluid

Mass transfer across the membrane is shown in Figure 10 below. It is found that the higher the fluid capacity supplied to the microchannel, the higher the mass transfer across the membrane.

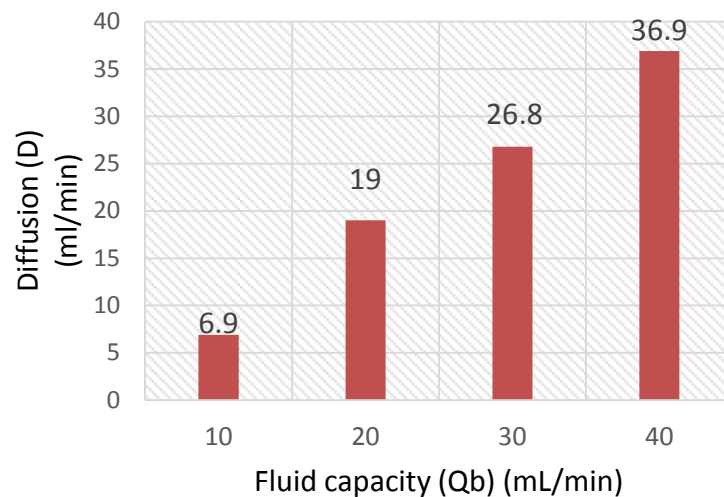

Figure 10. Mass transfer across the membrane

This study found that the rise of the mass transfer across the membrane almost the same to the rise of the fluid capacity. This result matches well to the work of Elout [6] using solute Urea and vitamin B12.

4. Conclusions

- The higher the velocity of the biofluid, the higher the mass transfer and shear stress occurred on the hemodialysis process.
- The pressure on the membrane surface is higher than the pressure in the pore of the membrane.
- The higher the dialysate flow, the higher the mass transfer occurs.

References

- <https://www.republika.co.id/berita/gaya-hidup/info-sehat/18/05/06/p8ap02399> jumlah pasien-penyakit-ginjal-kronis-terus-meningkat
- Ronco, C, Ghezzi, P.M., Brendolan, A, Crepaldi, C, La Greca, G, The haemodialysis system: basic mechanisms of water and solute transport in extracorporeal renal replacement therapies, *Nephrol Dial Transplant* 13 [Suppl 6]1998: 3–9
- Uhlenbusch-Körwer, E. Bonnie-Schorn, A. Grassmann, J. Vienken, *Understanding Membranes and Dialysers*, 2004
- Kerr, PG, Review: Membranes for haemodialysis, *Nephrolog* vol 15, 2010

- [5] Nur Kaliwantoro, Marsetyawan HNES, Indarto, Mohammad Juffrie, Rini Dharmastiti, CFD Simulation of Plasma Leakage and Fluid Flow on Dengue Virus Infected – Endothelial Cells, ARPN Journal of Engineering and Applied Science, Vol 11 No. 2, 2016
- [6] Eloot S., Experiment and Numerical Modelling of Dialysis, PhD Dissertaton, Ghent University, 2004